



Part No: **JSL-1001IRCC**

Features:

- High power output
- Low power consumption
- High reliability and long life

Descriptions:

- Dice material: AlGaAs
- Emitting Color: Infrared Emitting diodes
- Device Outline: ϕ 10mm Round Type/ 10mm
- Lens Type: Water Clear

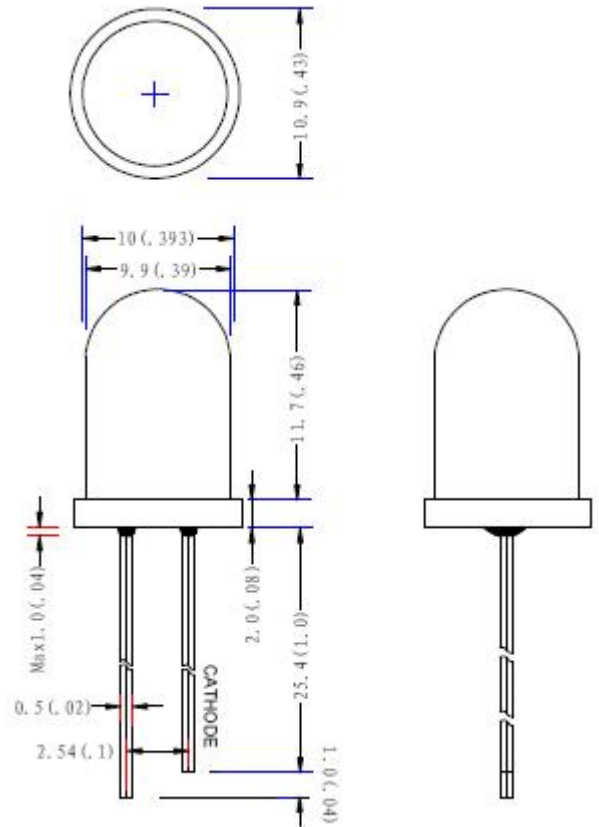

Directivity:

1. All dimensions are millimeters/单位: mm.
2. Tolerance is ± 0.25 mm unless otherwise noted/

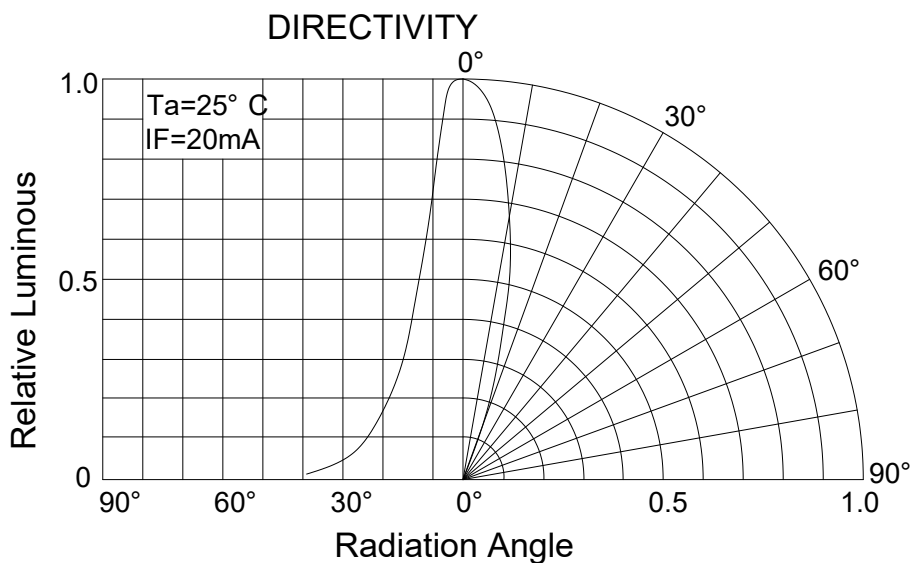



Part No: JSL-1001IRCC

Absolute maximum ratings (Ta = 25°C)

Parameter	Symbol	Test Condition	Values		Unit
			Min.	Max.	
Reverse Voltage	V _R	I _R = 10 μ A	9	--	V
Forward Current	I _{FM}	Duty=0.01ms 1khz	----	25	mA
Power Dissipation	P _d	----	----	100	mW
Pulse Current	I _{peak}	Duty=0.1mS, 1kHz	----	100	mA
Operating Temperature	T _{opr}	----	-40	+85	°C
Storage Temperature	T _{str}	----	-40	+100	°C

Electrical and optical characteristics (Ta = 25°C)

Parameter	Symbol	Test Condition	Values			Unit 单位
			Min.	Typ.	Max.	
Forward Voltage	V _F	I _F =50mA	----	1.5	1.7	V
Reverse Current	I _R	V _R =9V	----	----	10	μ A
Dominate Wavelength	λ _d	I _F =50mA	----	850	----	nm
Spectral Line half-width	Δ λ	I _F =50mA	----	45	50	nm
Luminous Intensity	I _e	I _F =50mA	90	130	----	mW/Sr
Viewing Angle	2 θ 1/2	I _F =50mA	15	20	25	deg.



Typical electrical/optical characteristic curves:

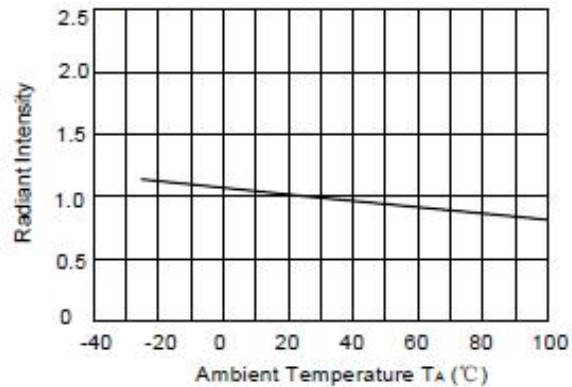
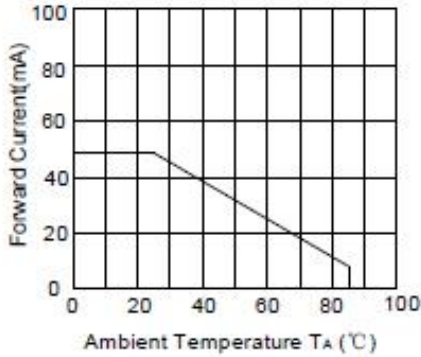
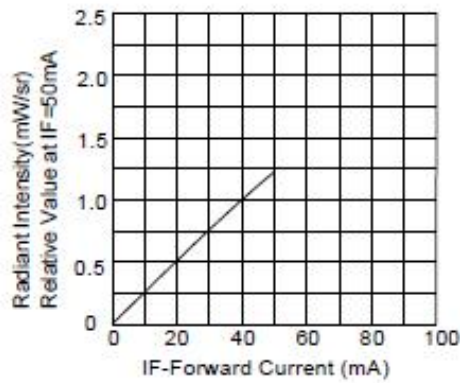
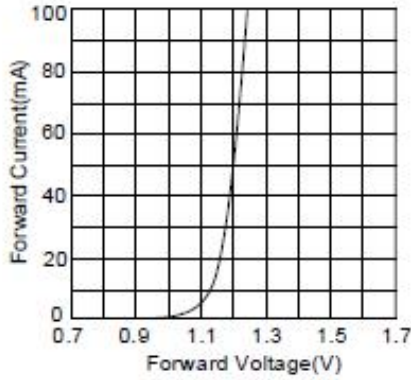

Spectral Reduance

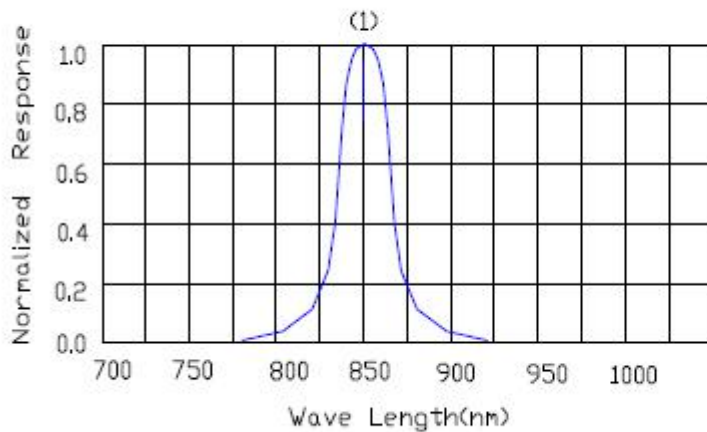

(1)peak@850nm /Infrared